



Throwing Game

- index -



GA162

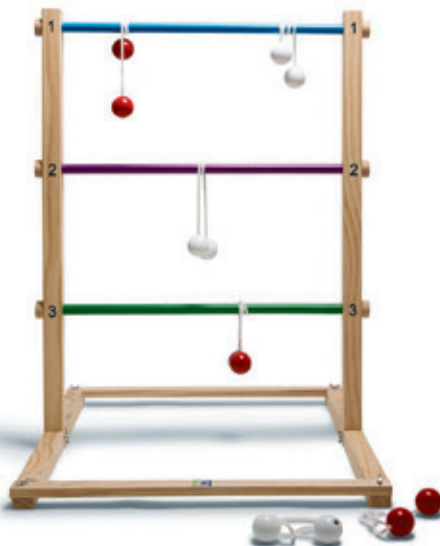

EN

p. 4

NL

p. 5

JP

p. 7

DE

p. 6

IT

p. 7



NL Waarschuwing. Niet geschikt voor kinderen jonger dan 36 maanden. Kleine onderdelen. Verstikkingsgevaar. Lang koord. Wurgingsgevaar. **EN** Warning. Not suitable for children under 36 months. Small parts. Choking hazard. Long cord. Strangulation hazard. **FR** Attention. Ne convient pas aux enfants de moins de 36 mois. Petits éléments. Danger d'étouffement. Longue corde. Danger de strangulation. **DE** Achtung. Nicht für Kinder unter 36 Monaten geeignet. Kleine Teile. Erstickungsgefahr. Lange Schnur. Strangulationsgefahr. **DA** Advarsel. Ikke egnet til børn under 36 måneder. Små dele. Kvælningsfare. Lang snor. Strangleringsfare. **EE** Hoiatus. Ei ole sobiv alla 36 kuu vanuste lastele. Väikesed osad. Kägistamisohut. Pikk nõõr. Poomisohut. **FIN** Varoitus. Ei sovelly alle 36 kuukauden ikäisille lapsille. Pieniä osia. Tukehtumisvaara. Pitkää naru. Kuristumisvaara. **GRE** Προειδοποίηση. Δεν είναι κατάλληλο για παιδιά κάτω των 36 μηνών. Μικρά μέρη. Κίνδυνος πνιγμού. Μακρύ κορδόνι. Κίνδυνος στραγγαλισμού. **IT** Avvertenza. Non adatto a bambini di età inferiore a 36 mesi. Piccole parti. Rischio di soffocamento. Corde lunghe. Rischio di strangolamento. **NO** Advarsel. Ikke egnet for barn under 36 måneder. Små deler. Kvelningsfare. Lang snor. Kvelningsfare. **PL** Ostrzeżenie. Nie nadaje się dla dzieci w wieku poniżej 36 miesięcy. Małe części. Niebezpieczeństwo udławienia się. Długa linka. Niebezpieczeństwo zadziernięcia. **PT** Atenção. Contra-indicado para crianças com menos de 36 meses. Pequenas partes. Risco de asfixia. Corda comprida. Risco de estrangulamento. **RO** Avertisment. Contraindicat copiilor mai mici de 36 de luni. Părți mici. Pericol de sufocare internă. Coardă lungă. Pericol de strangulare. **SL** Upozornenie. Nevhodné pre deti vo veku do 36 mesiacov. Majhni deli. Nevarnost zadušitve zaradi tujka. Dolga vrvica. Nevarnost zadavitve. **ES** Advertencia. No conviene para niños menores de 36 meses. Partes pequeñas. Peligro de atragantamiento. Cuerda larga. Peligro de estrangulamiento. **SV** Varning. Inte lämplig för barn under 36 månader. Små delar. Kvävningrisk. Långt snöre. Risk för strypning. **JP** 小部品があります。誤飲、窒息の危険がありますので、3歳未満のお子さまには絶対に与えないでください。ひもは指や首に巻きつきませんでください。



Copyright © 2023 by BuitenSpeel B.V. / All right reserved.

All rights reserved. No part of this publication may be reproduced, distributed, or transmitted in any form or by any means, including photocopying, recording, or other electronic or mechanical methods, without the prior written permission of BuitenSpeel B.V.

BuitenSpeel B.V. | Nieuwe Gracht 45-47 | 2011 ND Haarlem | The Netherlands



8 717775 44 625 2



Throwing Game

GA162

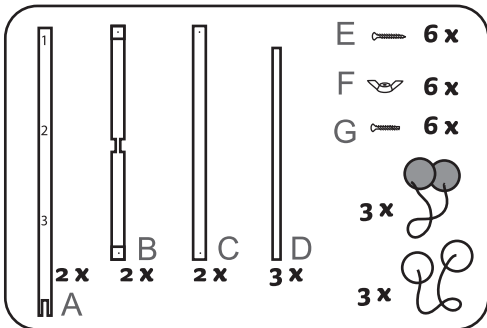
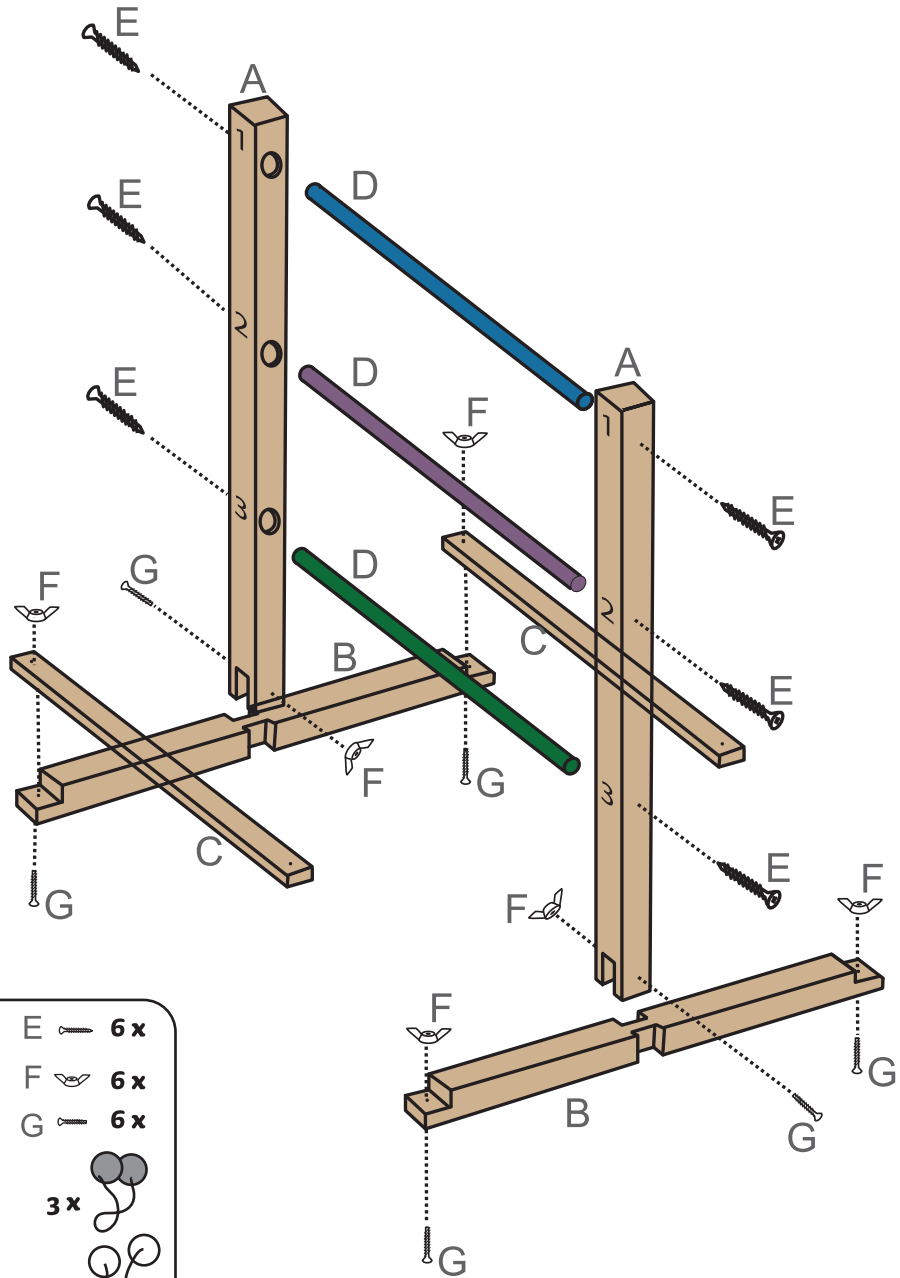



Throwing Game

GA162

EN

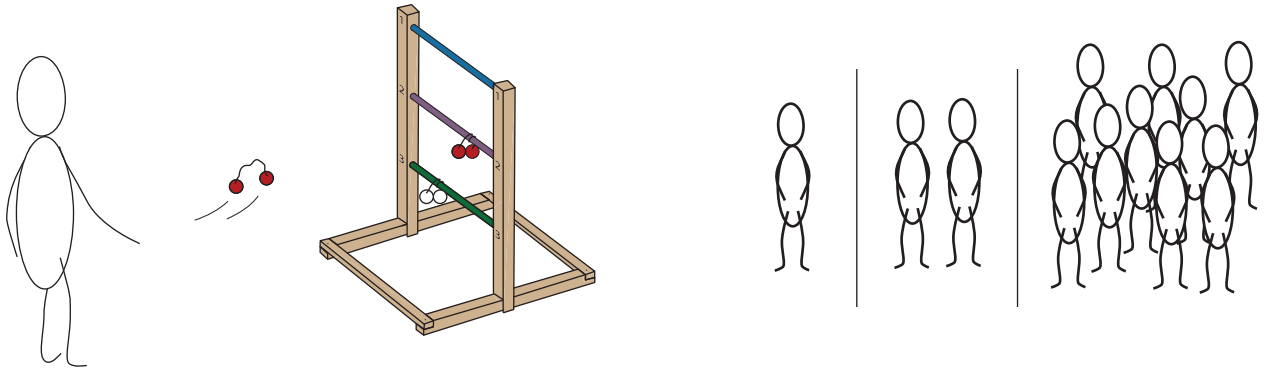

The purpose of the game is to score points by throwing the bolas so that they cling to the frame. If they do, you score the number of points, noted on the sides.

Teams: Play with two teams, with each team consisting of one or more players

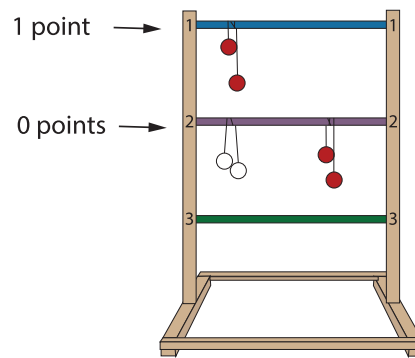
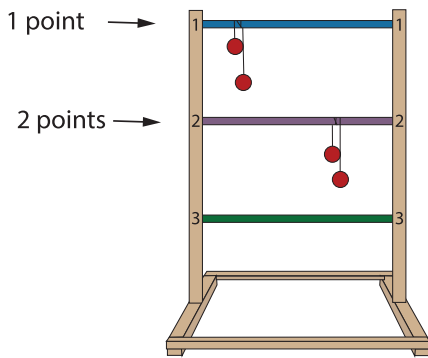

Throwing the bolas: Players take turns throwing both bolas at the ladder. They must stand behind the designated throwing line and must release the bolas before stepping over the line.

Scoring: Points are earned by the bolas that are wrapped around a rung or that are resting on a rung

Cancelling: If an opponent's bolas land on the same rung as a player's bolas, the points are cancelled. For instance, if Player A throws onto the middle rung, they earn 2 points. However, if the opponent also lands their bolas on that same rung, the points cancel out, resulting in a net score of 0. It's important to note that points can only be cancelled when the bolas are on the exact same rung

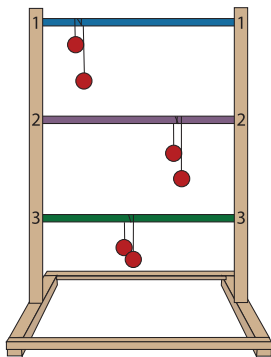

5 points

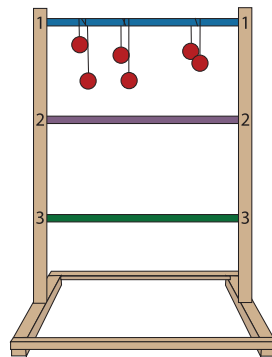

3 points

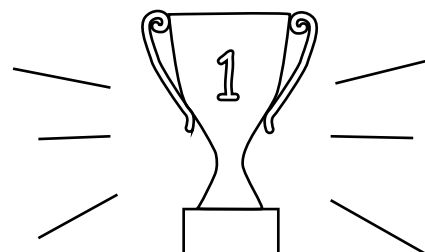

extra points:
5 bonus pts for a full house (a bola on each of the rungs)
3 bonus pts for a triple (three bola on one rung)

Winning the game: The game is won by the team that scores 21 points first. If a team goes over 21 points, their score of that round does not count.



Throwing Game

GA162

NL

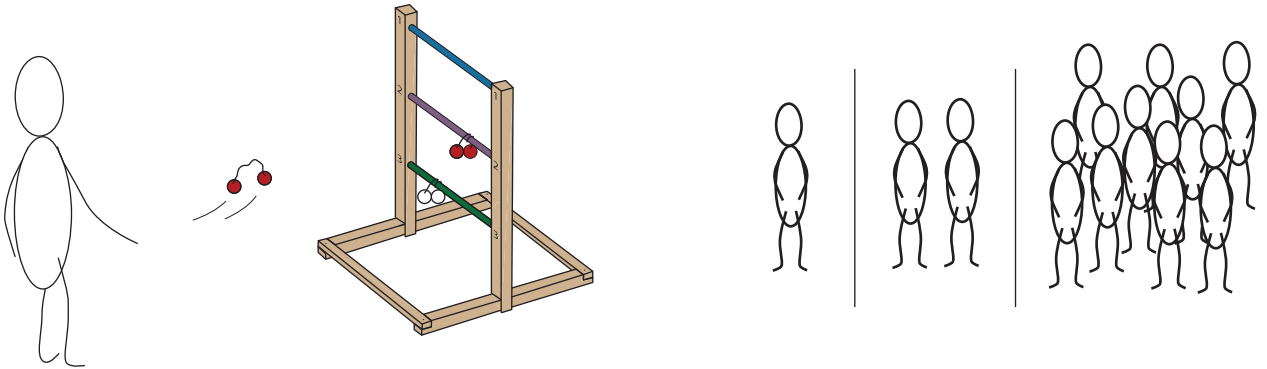

Het doel van het spel is punten te scoren door de bolas zo te gooien dat ze aan het frame blijven hangen. Als dit gebeurt, scoor je het aantal punten, vermeld aan de zijkanten.

Teams: Speel met twee teams, waarbij elk team bestaat uit één of meer spelers.

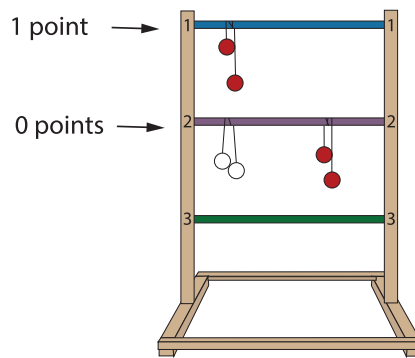
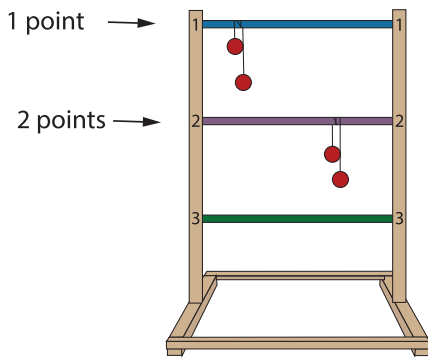

Gooien van de bolas: De spelers gooien beurtelings de bolas naar de ladder. Ze moeten achter de aangewezen gooilijn staan en de bolas moeten ze loslaten voordat ze over de lijn stappen.

Annulering: Als de bolas van een tegenstander op dezelfde sport landen als de bolas van een speler, worden de punten geannuleerd. Bijvoorbeeld, als speler A op de middelste sport gooit, verdient hij 2 punten. Maar als de tegenstander ook zijn bolas op diezelfde sport landt, annuleren de punten elkaar, waardoor er een nettoscore van 0 overblijft. Het is belangrijk om op te merken dat punten alleen geannuleerd kunnen worden wanneer de bolas precies op dezelfde sport liggen.

Scoren: Punten worden verdiend door de bolas die om een sport zijn gewikkeld of die op een sport rusten.

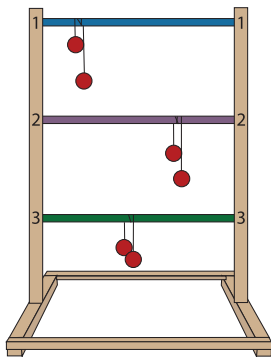

5 points

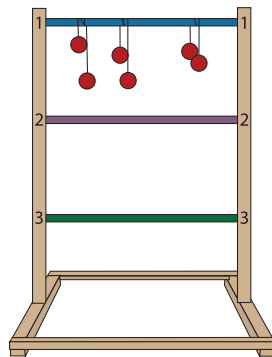

3 points



extra punten:

5 bonus pts voor een full house (een bola op iedere sport)
3 bonus pts voor een triple (drie bolas op één sport)

Winnaar: Het spel wordt gewonnen door het team dat als eerste 21 punten scoort. Als een team meer dan 21 punten heeft, telt hun score van die ronde niet mee.



Throwing Game

GA162

DE

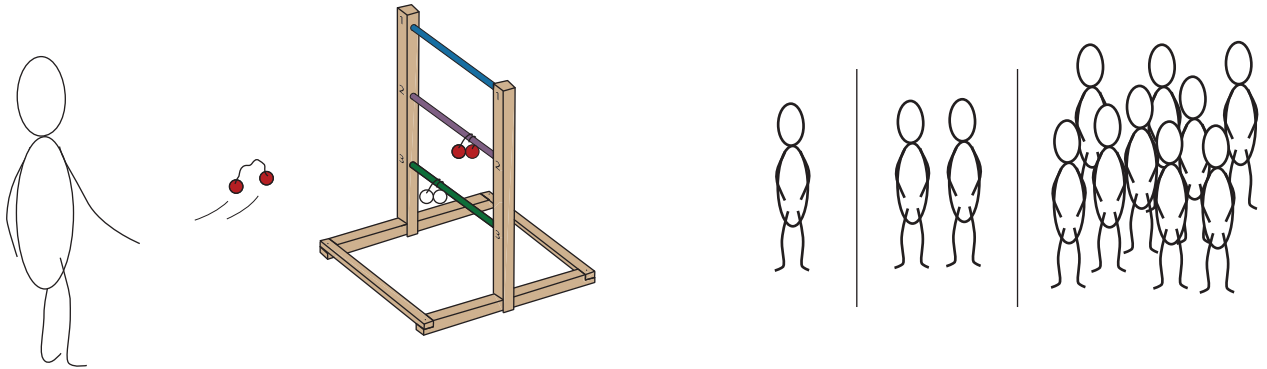

Der Zweck des Spiels besteht darin, Punkte zu erzielen, indem man die Bolas so wirft, dass sie am Rahmen hängen bleiben. Wenn sie das tun, erzielst du die Anzahl der Punkte, die an den Seiten vermerkt sind.

Spieler mit zwei Teams, wobei jedes Team aus einem oder mehreren Spielern besteht.

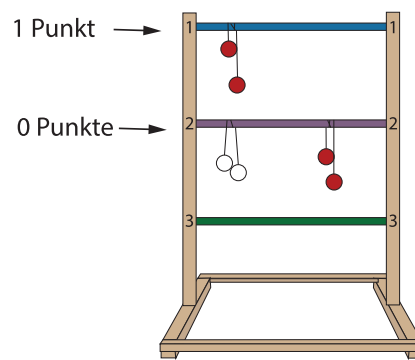
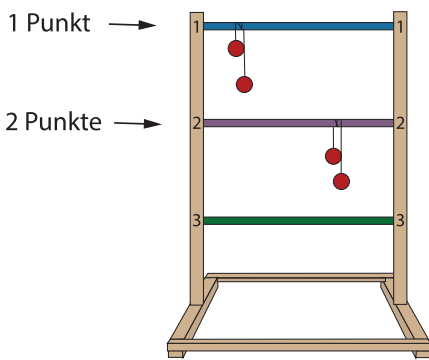

Das Werfen der Bolas: Die Spieler wechseln sich ab, indem sie beide Bolas auf die Leiter werfen. Sie müssen hinter der vorgesehenen Wurflinie stehen und die Bolas müssen freigegeben werden, bevor sie über die Linie treten.

Punktevergabe: Punkte werden durch die Bolas verdient, die um eine Stange gewickelt sind oder die auf einer Stange ruhen.

Stornierung: Wenn die Bolas des Gegners auf der gleichen Stange landen wie die Bolas eines Spielers, werden die Punkte storniert. Wenn beispielsweise Spieler A auf die mittlere Stange wirft, erhält er 2 Punkte. Wenn jedoch die Bolas des Gegners auf dieser gleichen Stange landen, werden die Punkte storniert, was zu einem Nettoergebnis von 0 führt. Es ist wichtig zu beachten, dass Punkte nur storniert werden können, wenn die Bolas sich auf der exakt gleichen Stange befinden.

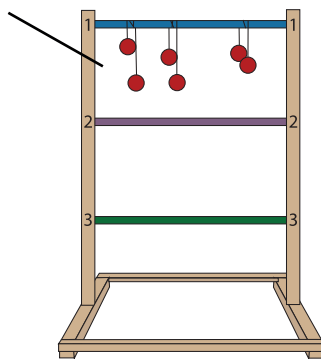
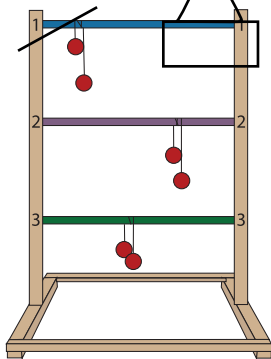

Bonuspunkte:

5 Bonuspunkte für ein Full House (eine Bola auf jeder Stange)
3 Bonuspunkte für ein Triple (drei Bolas auf einer Stange)

Das Spiel gewinnen: Das Spiel wird vom Team gewonnen, das zuerst 21 Punkte erzielt. Wenn ein Team jedoch mehr als 21 Punkte erzielt, wird seine Punktezahl in dieser Runde nicht gezählt.



Throwing Game

GA162

IT

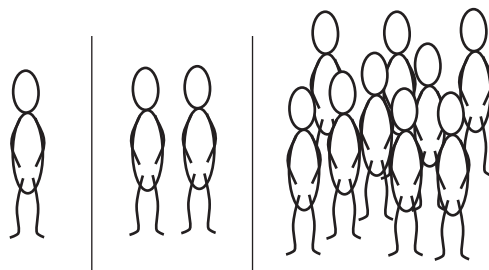
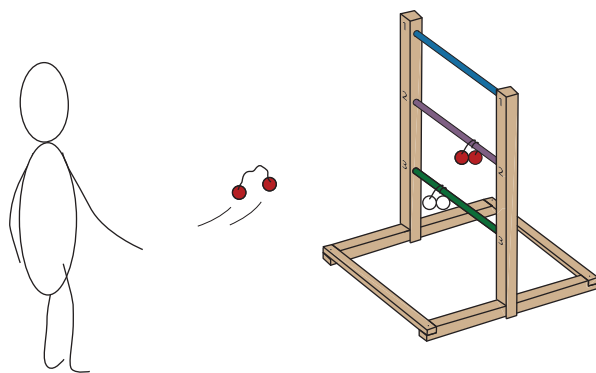

Scopo del gioco: lo scopo del gioco è quello di guadagnare punti lanciando le bolas in modo che rimangano appese al telaio. Se ciò accade, guadagni il numero di punti indicato sui lati.

Squadre: Formate due squadre - ogni squadra può essere composta da uno o più giocatori.

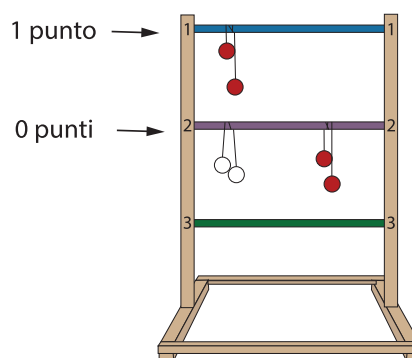
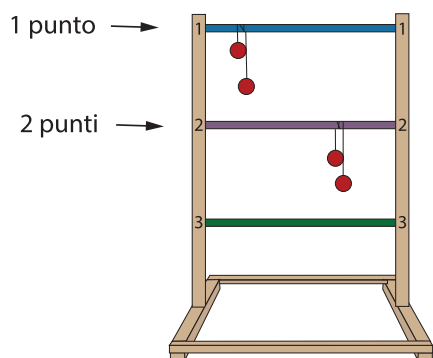

Lanciare le bolas: i giocatori si alternano lanciando entrambe le bolas sulla scala. Devono stare dietro la linea di lancio designata e devono rilasciare le bolas prima di oltrepassare la linea.

Punteggio: il punteggio si calcola sommando il valore su ogni asticella in cui la bolas o le varie bolas risultano rimaste appese o intrecciate sull'asticella stessa.

Annullamento: Se le bolas dell'avversario si posizionano sulla stessa asticella in cui si trova già la bolas dell'altra squadra, quel punteggio si annulla ed è pari a 0. Ad esempio se un giocatore riesce a posizionare una bolas sull'asticella centrale, guadagna 2 punti; tuttavia se il giocatore dell'altra squadra riesce a posizionare anche la sua bolas sulla stessa asticella, i rispettivi punti totalizzati su quella asticella si annullano. È importante notare che i punti si annullano solo nel caso le rispettive bolas si trovino sulla stessa asticella.

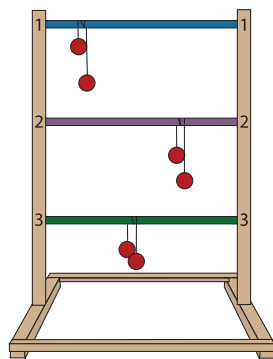

5 punti

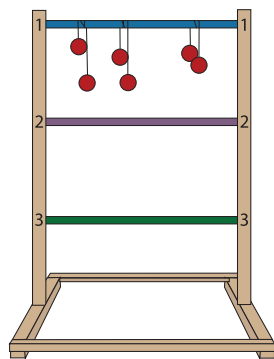

3 punti

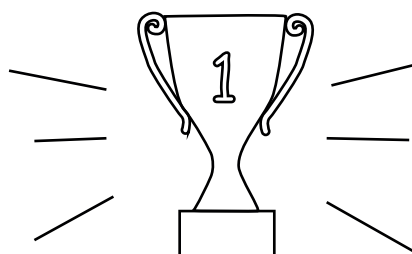

Punti bonus: 5 punti bonus per un full house (una bola su ogni pertica) e 3 punti bonus per un tris (tre bolas su una asticella).

Vincere il gioco: Il gioco termina quando una delle due squadre raggiunge o supera per prima i 21 punti - la squadra che raggiunge o supera 21 punti, ha vinto la partita.



BSラダーゲーム

TYBSTGA162

6歳から

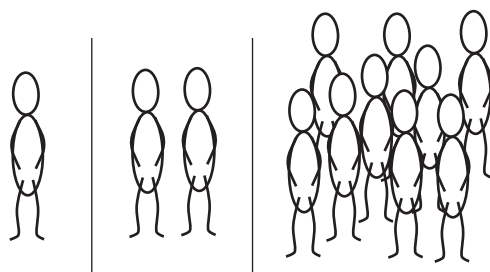
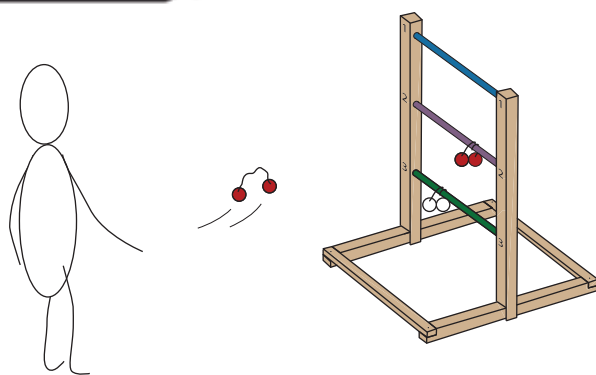

遊び方

ボーラ(両端に球状のおもりが付いたひも)を投げてラダー(はしご)に巻きつけます。ラダーの正面に書かれた点数分の得点が得られます。

チーム

2つのチームでプレイします。各チームは1人または複数人のプレイヤーで構成されます。

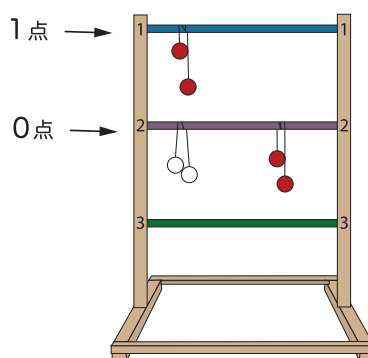
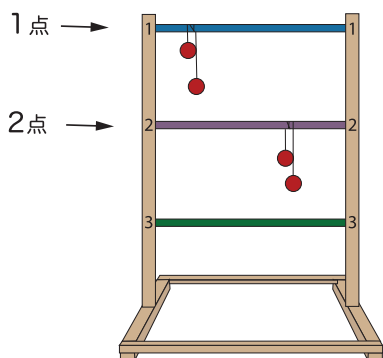

ボーラの投げ方

決められたラインの後ろから、両チームが3投ずつラダーに向かってボーラを投げます。

キャンセル

相手のボーラが同じ段に引っ掛かった場合に、得点が取り消されます。例えばプレイヤーAが真ん中の段に引っ掛けた場合、2点を獲得します。しかし、プレイヤーBも真ん中の段に引っ掛けた場合は点数が相殺されます。

得点

ボーラがラダーに引っ掛かると得点となります。※スペシャルポイントはキャンセルに影響されず付与されます。

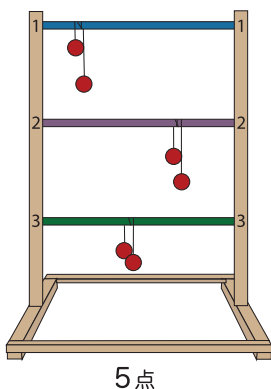

5点

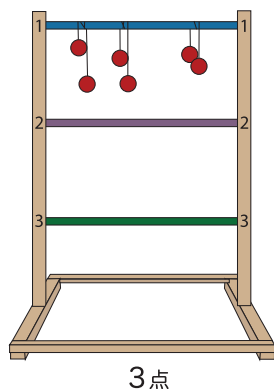

3点



ゲームの勝敗

ぴったり21点を先に獲得したチームが勝ちとなります。ラウンド中に21点を越えた場合は、そのラウンドの得点はカウントされません。例えば、プレイヤーAが3ラウンドで18点獲得しています。4ラウンド目で4点獲得した場合は22点となり、21点を越えてしまいます。5ラウンド目は18点からスタートとなります。

スペシャルポイント

フルハウス(各段に1つずつボーラがある) : 5ポイントのボーナス
トリプル(1つの段に3つのボーラがある) : 3ポイントのボーナス